

# trivum®

smart multiroom

## trivum speaker wiring



### *Manual*

Geoffrey Heinzl

August 2016

# Speaker wiring

(using all the same type of speakers)

We are often asked what should we do if we need to connect more than one pair of speakers to the trivum multiform amplifier in one zone. Here are the answers on how to wire the speakers in order to **not** go below the critical impedance of 4 ohms to damage the amplifiers.

The term '**speakers**' is used which could be In Ceiling, In Wall speakers or speakers in cabinets that you are trying to wire up into a network and balance the loads appropriately.

Each element shown in the drawings is represented as a speaker symbol.

Each speaker symbol counts as a load.

In the case of dual voice coil, In Ceiling "Stereo Speaker" or Sub-Woofer drivers, appear (electrically) as if they are 2 speakers. Use the **2 Speakers - (In Phase)** information to figure out how to wire them up if both coils are to be connected to the same power amplifier.

Shown are 1, 2, 4, 6, 8, 12 and 16 ohm loads (voice coil impedance or total cabinet impedance). These are the most likely combinations of wiring that you will run into.

## 2 Speakers - Series Wiring; In Phase

**NOTE:** If you have a dual voice coil speaker and you want to use both voice coils to drive the same signal, you would wire it like this. The impedance results are noted below.

- - 1 ohm loads - total load = 2 ohms
  - 2 ohm loads - total load = 4 ohms
  - 4 ohm loads - total load = 8 ohms
  - 6 ohm loads - total load = 12 ohms
  - 8 ohm loads - total load = 16 ohms
  - 12 ohm loads - total load = 24 ohms
  - 16 ohm loads - total load = 32 ohms

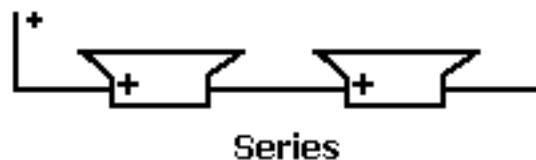

**The impedance is additive. Add up all the loads to figure out the total load value.**

- **Add up all the series loads:**
- **Total Load = S1 + S2**
- **Where:**
- **S1 = the impedance of Speaker load # 1**
- **S2 = the impedance of Speaker load # 2**

## 2 Speakers - Series Wiring; Out Of Phase

**NOTE: Never** wire a speaker cabinet **Out Of Phase** unless it requires a **Push-Pull/Isobaric** alignment. Dual Driver Sub-Woofers would use this (not single drivers with Dual Voice Coils).

- 1 ohm loads - total load = 2 ohms
- 2 ohm loads - total load = 4 ohms
- 4 ohm loads - total load = 8 ohms
- 6 ohm loads - total load = 12 ohms
- 8 ohm loads - total load = 16 ohms
- 12 ohm loads - total load = 24 ohms
- 16 ohm loads - total load = 32 ohms



**The impedance is additive. Add up all the loads to figure out the total load value.**

- **Add up all the series loads:**
- **Total Load = S1 + S2**
- **Where:**
- **S1 = the impedance of Speaker load # 1**
- **S2 = the impedance of Speaker load # 2**
- **The Red Speaker is the one that is Out Of Phase.**

## 2 Speakers - Parallel Wiring; In Phase

**NOTE:** If you have a dual voice coil speaker and you want to use both voice coils to drive the same signal, you would wire it like this. The impedance results are noted below.

- - 1 ohm loads - total load = .5 ohms
  - 2 ohm loads - total load = 1 ohm
  - 4 ohm loads - total load = 2 ohms
  - 6 ohm loads - total load = 3 ohms
  - 8 ohm loads - total load = 4 ohms
  - 12 ohm loads - total load = 6 ohms
  - 16 ohm loads - total load = 8 ohms

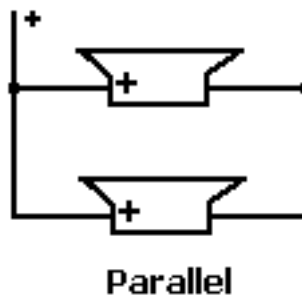

**The impedance decreases.  
The equation is**

- **Total Load =  $(S1 \times S2) / (S1 + S2)$**
- **Where:**
- **S1 = the impedance of Speaker load # 1**
- **S2 = the impedance of Speaker load # 2**
- **Another way to define this is:**
- **$1/\text{Total Load} = 1/S1 + 1/S2$**

## 2 Speakers - Parallel Wiring; Out Of Phase

**NOTE: Never** wire a speaker cabinet **Out Of Phase**. Serious damage to the speakers (dual VoiceCoil) or least complete cancellation of all low frequencies will be the result.

- 1 ohm loads - total load = .5 ohms
- 2 ohm loads - total load = 1 ohm
- 4 ohm loads - total load = 2 ohms
- 6 ohm loads - total load = 3 ohms
- 8 ohm loads - total load = 4 ohms
- 12 ohm loads - total load = 6 ohms
- 16 ohm loads - total load = 8 ohms

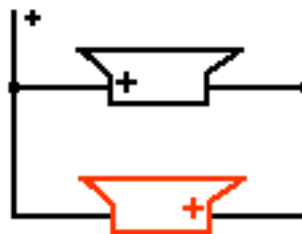

Out Of Phase Parallel

**The impedance decreases. The equation is**

- **Total Load =  $(S1 \times S2) / (S1 + S2)$**
- **Where:**
- **S1 = the impedance of Speaker load # 1**
- **S2 = the impedance of Speaker load # 2**

**The Red Speaker is the one that is Out Of Phase.**

## 4 Speakers - Serial Wiring; In Phase

- 1 ohm loads - total load = 4 ohms
- 2 ohm loads - total load = 8 ohms
- 4 ohm loads - total load = 16 ohms
- 6 ohm loads - total load = 24 ohms
- 8 ohm loads - total load = 32 ohms
- 12 ohm loads - total load = 48 ohms
- 16 ohm loads - total load = 64 ohms

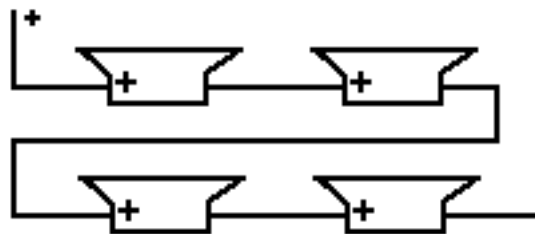

Series

**The impedance is additive. Add up all the loads to figure out the total load value.**

- **Add up all the series loads:**
- **Total Load = S1 + S2 + S3 + S4**
- **Where:**
- **S1 = the impedance of Speaker load # 1**
- **S2 = the impedance of Speaker load # 2**
- **S3 = the impedance of Speaker load # 3**
- **S4 = the impedance of Speaker load # 4**

## 4 Speakers - Parallel Wiring; In Phase

- 1 ohm loads - total load = .25 ohms
- 2 ohm loads - total load = .5 ohms
- 4 ohm loads - total load = 1 ohm
- 6 ohm loads - total load = 1.5 ohms
- 8 ohm loads - total load = 2 ohms
- 12 ohm loads - total load = 3 ohms
- 16 ohm loads - total load = 4 ohms

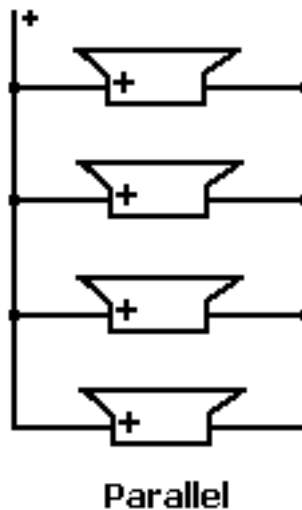

**The impedance decreases. The equation is**

- **$1/\text{Total Load} = 1/S1 + 1/S2 + 1/S3 + 1/S4$**
- **Where:**
- **S1 = the impedance of Speaker load # 1**
- **S2 = the impedance of Speaker load # 2**
- **S3 = the impedance of Speaker load # 3**
- **S4 = the impedance of Speaker load # 4**



## 4 Speakers - Series/Parallel Wiring; In Phase

- 1 ohm loads - total load = 1 ohm
- 2 ohm loads - total load = 2 ohms
- 4 ohm loads - total load = 4 ohm
- 6 ohm loads - total load = 6 ohms
- 8 ohm loads - total load = 8 ohms
- 12 ohm loads - total load = 12 ohms
- 16 ohm loads - total load = 16 ohms

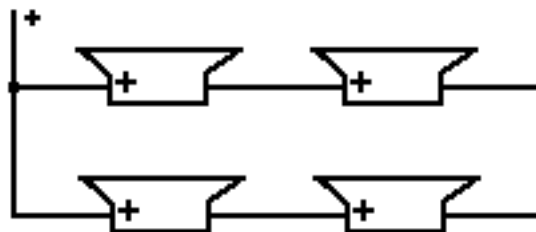

Series/Parallel

**The impedance is the result of the series load being wired in parallel.**

- **Add up all the series loads:**
- **$SL1 = S1 + S2$**
- **$SL2 = S3 + S4$**
- **Then Figure out the Parallel load**
- **Total Load =  $(SL1 \times SL2) / (SL1 + SL2)$**
- **Where:**
- **$S1$  = the impedance of Speaker load # 1**
- **$S2$  = the impedance of Speaker load # 2**
- **$S3$  = the impedance of Speaker load # 3**
- **$S4$  = the impedance of Speaker load # 4**
- **$SL1$  = the impedance of Speaker load # 1 + 2**
- **$SL2$  = the impedance of Speaker load # 3 + 4**

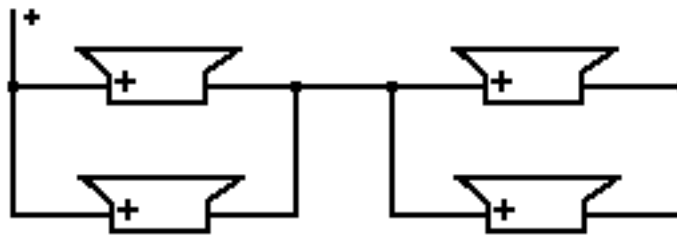

**Parallel/Series**

If you have Stereo InCeiling speakers or Dual Coil Sub-Woofers, or separate cabinets with 2 speakers in them you can wire this way (where both of the loads are shown as 2 speakers) - the resulting load is same as above.

### **8 Speakers - Series/Parallel Wiring; In Phase**

This is simply a variation of everything else here. 2 sets of 4 speakers wired in parallel, with those sets wired in series.

- 4 ohm loads - total load = 2 ohm
- 8 ohm loads - total load = 4 ohms
- 16 ohm loads - total load = 8 ohms

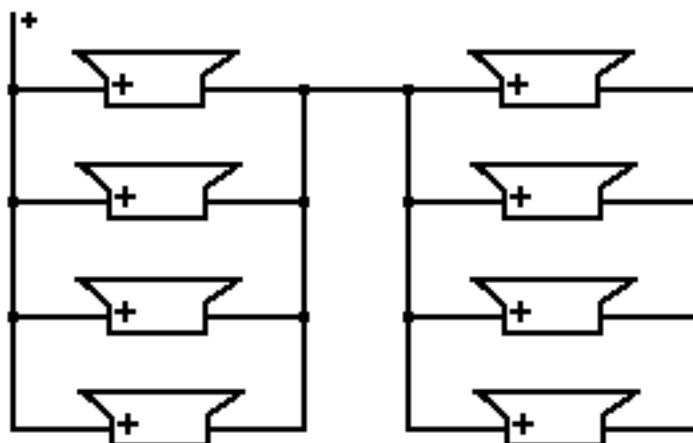

**8 Speakers Series/Parallel**

## Oddball Configurations

### 3 Speakers

This is usually a very poor combination if all the speakers are the same impedance and I strongly recommend against it. A lot of people ask me about a 3 speaker combination - I'm not sure why anyone would go out of their way to use this combination (2 or 4 speakers are easier to wire when all the speaker impedances are the same) - **NOTE: It is very easy to put together 3 speaker combinations that can damage your power amp because of too low of a load impedance - make sure that you choose your configuration carefully.**

Some options are:

#### All 3 speakers in series:

- For 4 ohm speakers, you get a 12 ohm load.
- For 6 ohm speakers, you get an 18 ohm load.
- For 8 ohm speakers, you get a 24 ohm load.
- For 16 ohm speakers, you get a 48 ohm load.

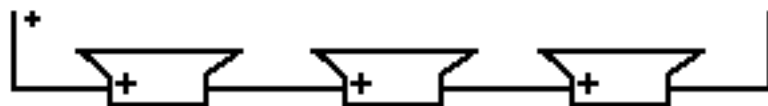

3 Speakers in Series

◦

#### All 3 speakers in parallel:

- For 4 ohm speakers, you get a **1.33 ohm** load.
- **WARNING: Very few power amps can drive a 1.33 ohm load**
- For 6 ohm speakers, you get a **2 ohm** load.
- **WARNING: Power amp must be able to drive a 2 ohm load**
- For 8 ohm speakers, you get a **2.67 ohm** load.
- **WARNING: Power amp must be able to drive a 2 ohm load**
- For 16 ohm speakers, you get a **5.33 ohm** load.
- **NOTE: Works well with power amps designed for 4 ohm loads**

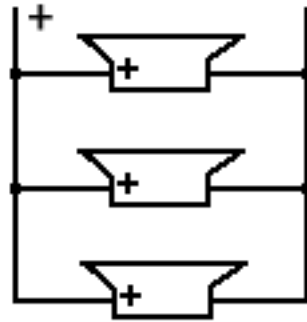

Parallel

- **Possible 3 speaker mixes that work:**
- 2 identical - 4 ohm speakers in series (8 ohms)
- then wired in parallel with an 8 ohm speaker = **4 ohms**

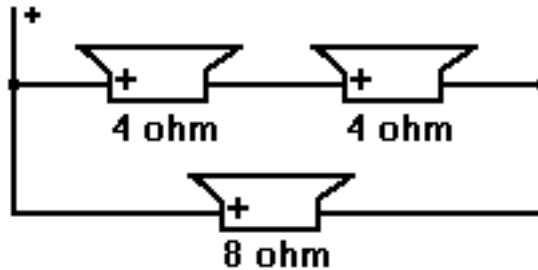

4 ohm Total Load

- 2 identical - 8 ohm speakers in series (16 ohms)
- then wired in parallel with a 16 ohm speaker = **8 ohms**

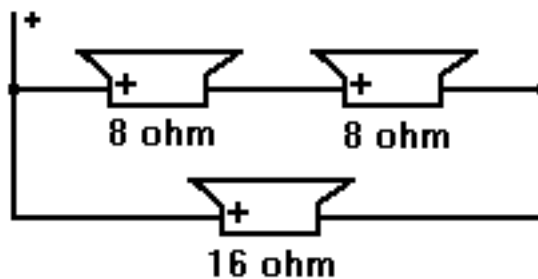

8 ohm Total Load

## 6 Speakers

This is sometimes a poor combination if all the speakers are the same impedance and I strongly suggest against it, however if your power amp can drive these loads, it will work. Some options are:

- **2 sets of 3 speakers in series, with those 2 sets in parallel:**

- For 4 ohm speakers, you get a **6 ohm** load.
- For 6 ohm speakers, you get an **9 ohm** load.
- For 8 ohm speakers, you get a **12 ohm** load.
- For 16 ohm speakers, you get a **24 ohm** load.

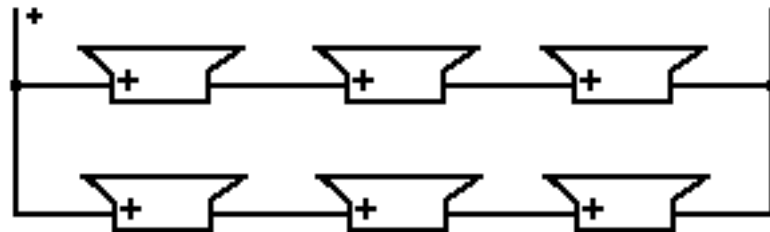

6 Speaker Series/Parallel

- **2 sets of 3 speakers in parallel, with those 2 sets in series:**

- For 4 ohm speakers, you get a **2.67 ohm** load.
- **WARNING:** Power amp must be able to drive a **2 ohm** load
- For 6 ohm speakers, you get an **4 ohm** load.
- For 8 ohm speakers, you get a **5.34 ohm** load.
- For 16 ohm speakers, you get a **10.66 ohm** load.

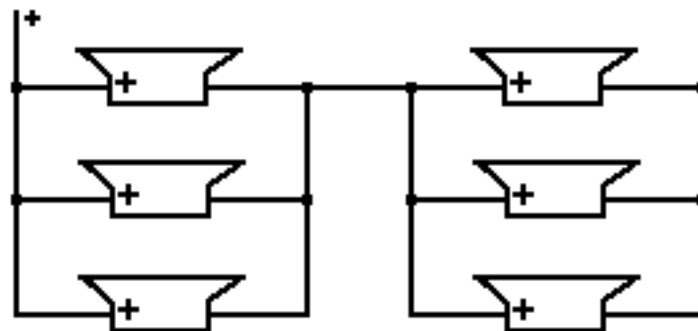

6 Speakers Series/Parallel

- **Possible mixes that work OK, but speaker loading may not be optimal:**
- 4 - 4 ohm speakers in series (16 ohms) then wired in parallel with 2 - 8 ohm speakers in series (16 ohms) = **8 ohm** load

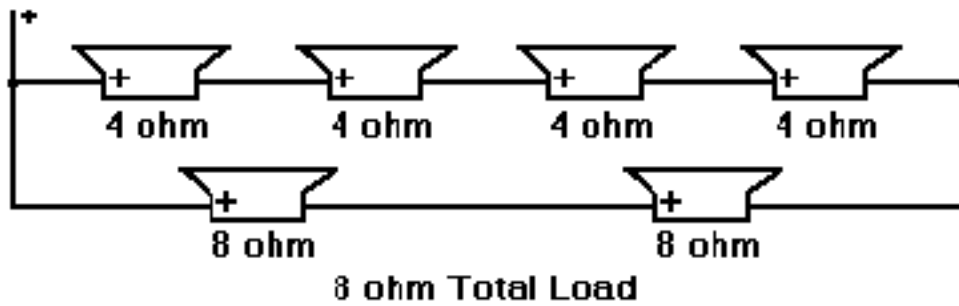

- 4 - 8 ohm speakers in parallel (2 ohms) then wired in series with a 2 - 4 ohm speakers that are wired in parallel (2 ohms) = **4 ohm** load **Warning:** the 4 ohm speakers will see 2 times the power that the 8 ohm speakers will see. Make sure they can handle it.

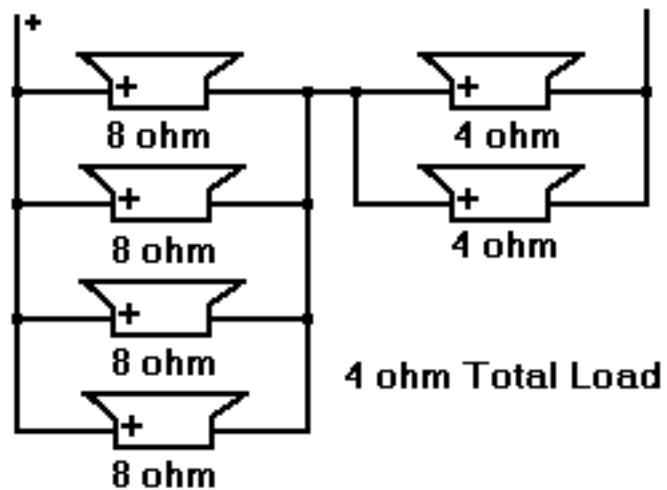

- 4 - 16 ohm speakers in parallel (4 ohms) then wired in series with a 2 - 8 ohm speakers that are wired in parallel (4 ohms) = **8 ohm** load **Warning:** the 8 ohm speakers will see 2 times the power that the 16 ohm speakers will see. Make sure they can handle it.

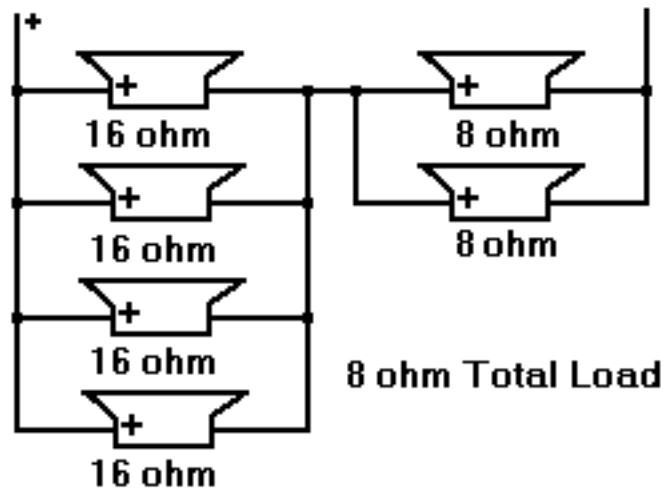

## 12 Speakers

- Not a very common set up. but I have been asked how to wire 12 speakers many times.

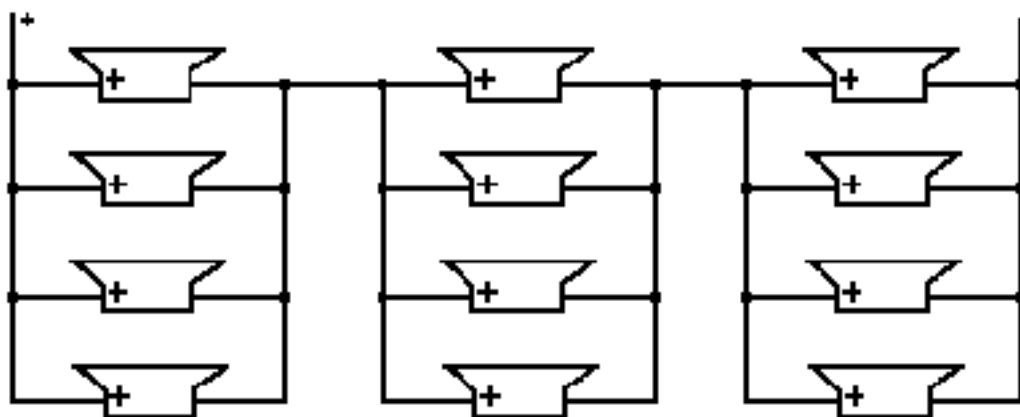

### 12 Speaker Wiring

If all are 4 ohms - Total Load = 3 ohms

If all are 6 ohms - Total Load = 4.5 ohms

If all are 8 ohms - Total Load = 6 ohms

## Dual Voicecoil Speaker wiring

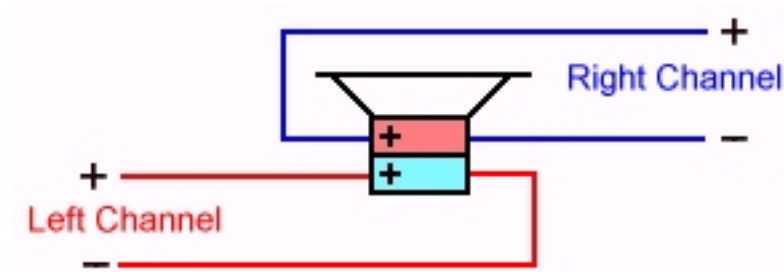

Typical wiring for a Stereo In-Ceiling or In-Wall speaker

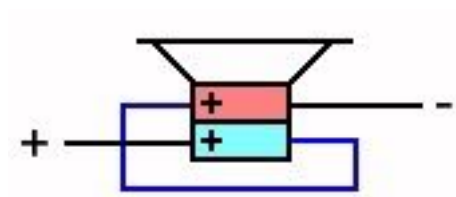

### Serial Wiring

Provides an Impedance of 2 times the single Voice Coil Impedance. Uses both voice coils wired in series.

- 2 ohm Voice Coils = 4 ohm load
- 4 ohm Voice Coils = 8 ohm load
- 6 ohm Voice Coils = 12 ohm load
- 8 ohm Voice Coils = 16 ohm load
- 16 ohm Voice Coils = 32 ohm load

**Warning:** You must wire these connections in Phase



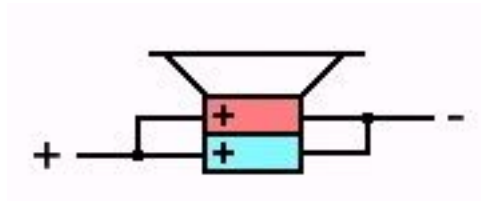

## Parallel Wiring

Provides an Impedance of 1/2 the single Voice Coil Impedance. Uses both voice coils wired in parallel.

- 2 ohm Voice Coils = 1 ohm load
- 4 ohm Voice Coils = 2 ohm load
- 6 ohm Voice Coils = 3 ohm load
- 8 ohm Voice Coils = 4 ohm load
- 16 ohm Voice Coils = 8 ohm load

**Warning:** You must wire these connections in Phase